

Model X





Model XPS

Panel Systems-30mm (R50)



Cluster Array Workstation

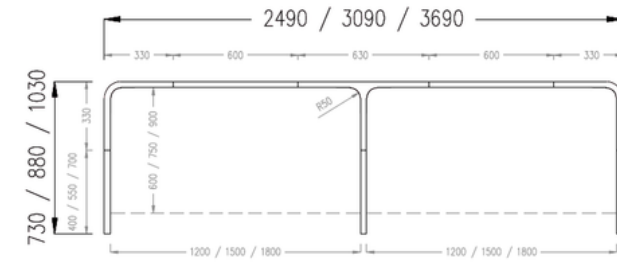

Cluster Array Workstation

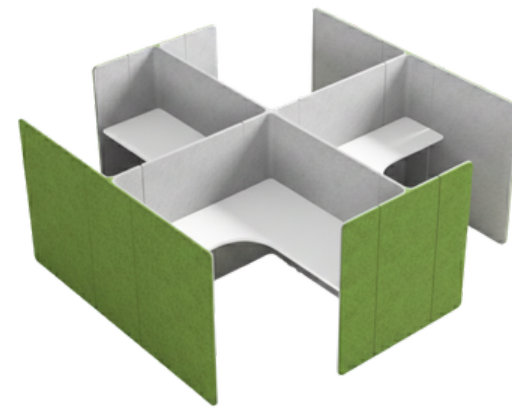
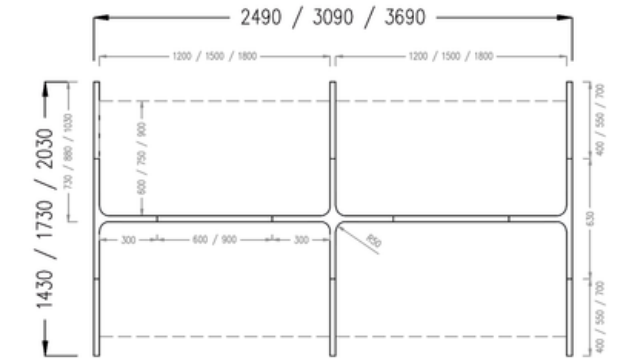
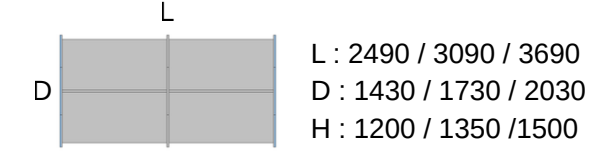

Cluster L-Shape Quad Workstation

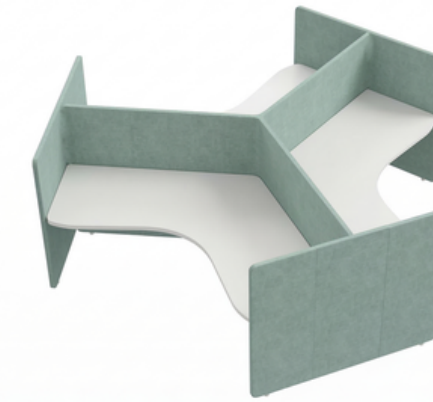
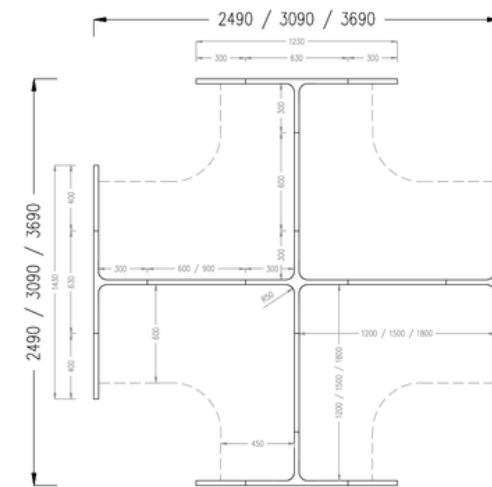
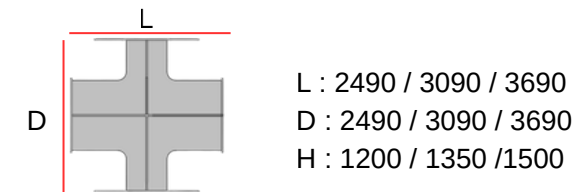

Cluster Y TRIP Workstation

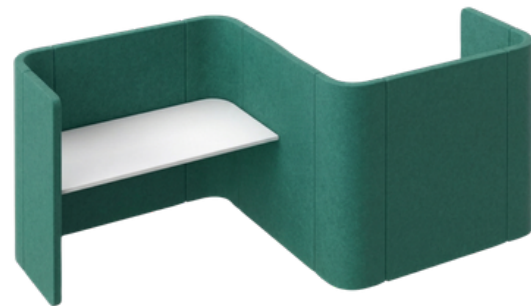
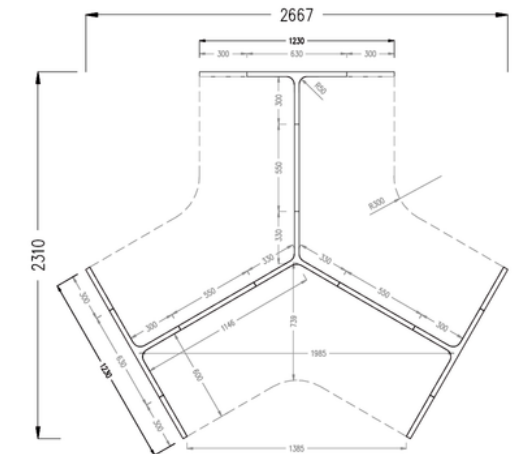
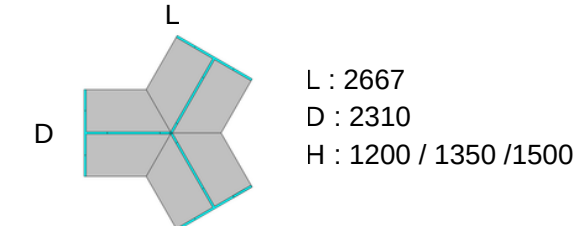

Cluster ORBIT Workstation

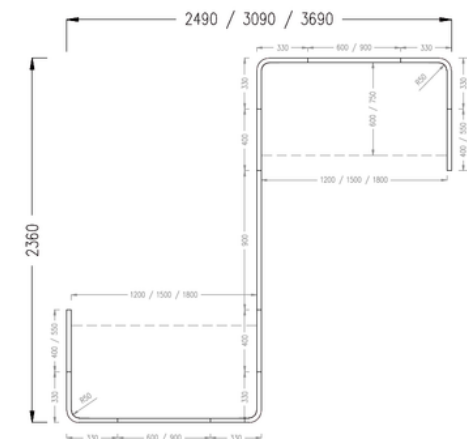

Cluster HEXA Workstation

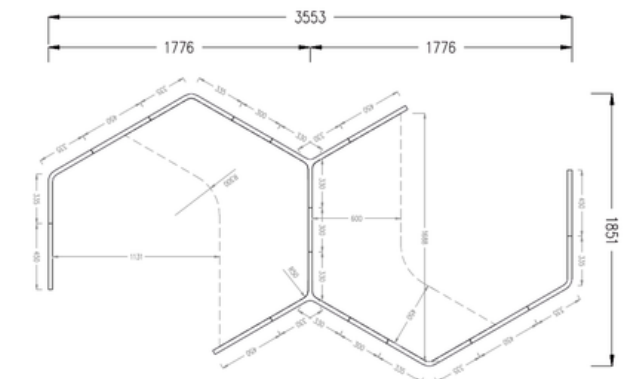
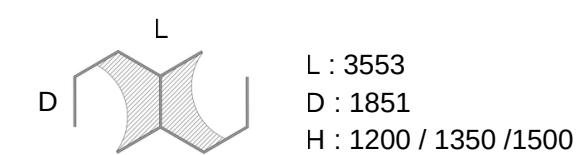



XPS-Cluster Array Workstation

The Cluster Array Workstation offers both cluster and linear configurations for a sleek, space-efficient office setup. Its modular frameless panel system supports flexible layouts, seamless expansion, and a clean modern aesthetic. Fully customizable to suit evolving workspace needs, it is available in standard tabletop sizes of L1200mm, L1500mm, and L1800mm.



XPS-Cluster L-Shape Quad Workstation

Designed for flexibility and scalability, the Cluster L-Shape Quad Workstation adapts easily to growing teams and changing office layouts. Its modular configuration maximizes workspace efficiency while creating comfortable individual work zones for improved focus and productivity.



XPS-Cluster Y TRIP Workstation



The Cluster Y TRIP Workstation combines collaborative planning with individual privacy in a compact, space-efficient layout. Its Y-shaped configuration encourages team interaction while maintaining focused personal work areas within modern office environments.



XPS-Cluster HEXA Workstation



The Cluster HEXA Workstation features a hexagonal modular layout designed to create private and focused workspaces within open-plan offices. Its enclosed panel design enhances acoustic comfort, improves concentration, and optimizes space utilization.



XPS-Cluster FLO Workstation



Inspired by soft flowing curves, the Cluster FLO Workstation brings a welcoming and contemporary feel to collaborative workspaces. Its open modular layout promotes communication, flexibility, and efficient workspace organization while enhancing modern office aesthetics.

XPS-Cluster ORBIT Workstation



The Cluster ORBIT Workstation features a soft curved pod-inspired design that creates semi-private work zones for focused productivity. Its modular enclosed layout improves privacy, reduces distractions, and delivers a refined contemporary workspace experience.

Model XPP

Pod Systems-35mm (R140)



U-Pod - Curved corners, Envelope ends

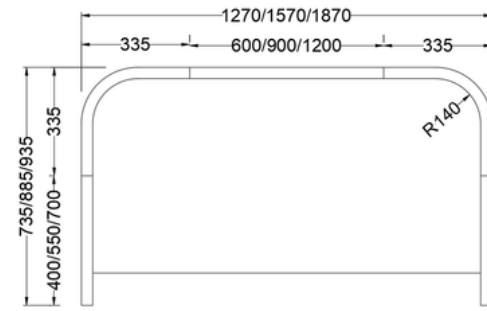
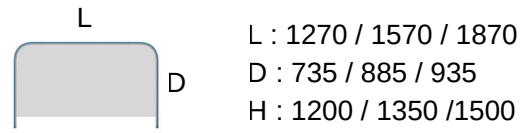

Recap Workpod - Curved corners

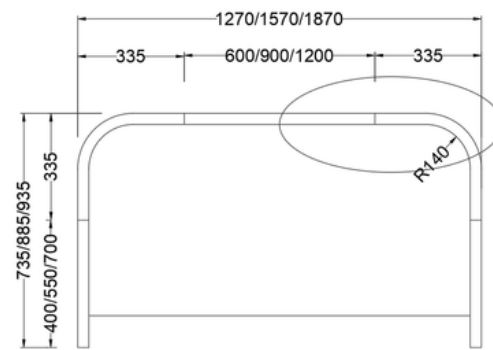
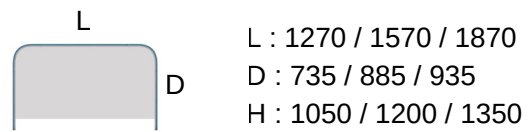

Conference Workpod - Curved corner

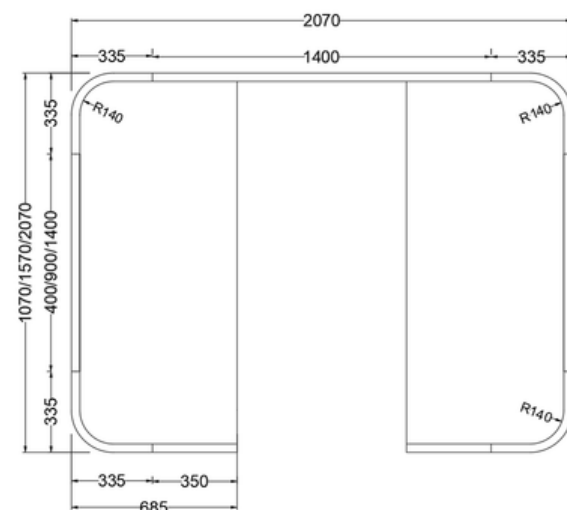
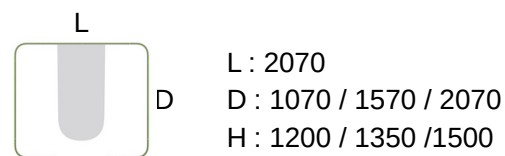

Cove Workpod - Curved corners, Envelope ends

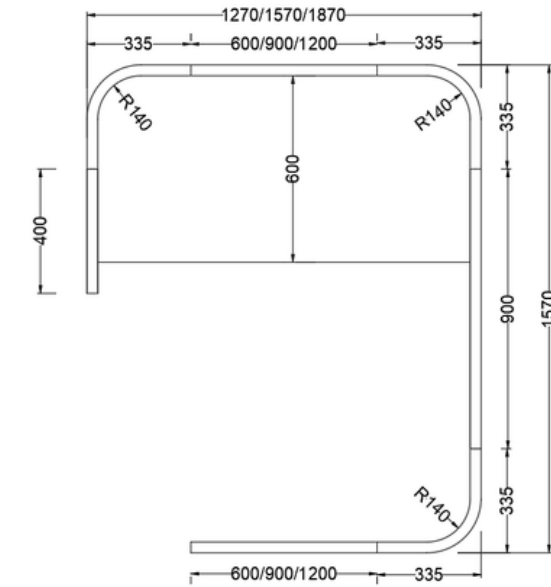
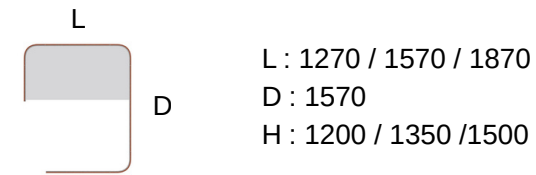

Collab Workpod - Curved corners, Envelope ends

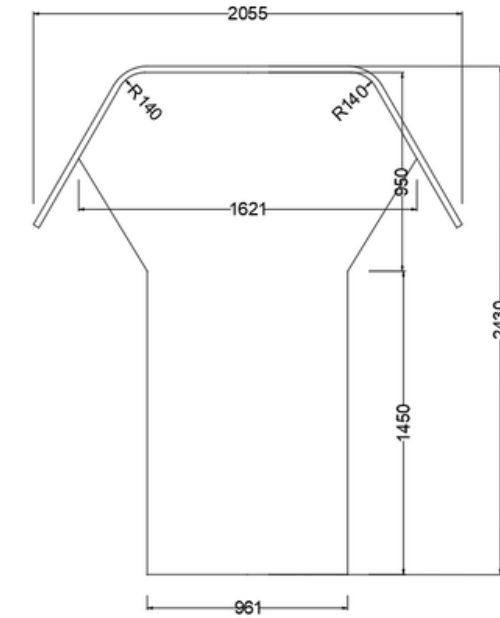
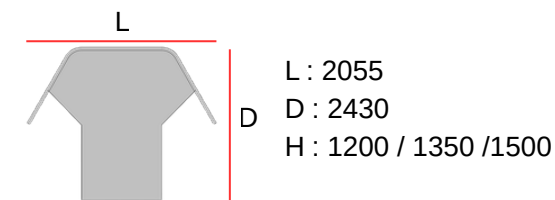

Uni Workpod - Curved corners, Envelope ends

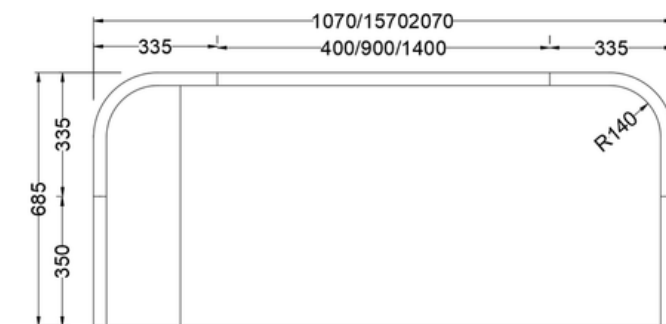
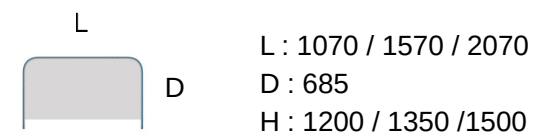

XPS-Cove Workpod

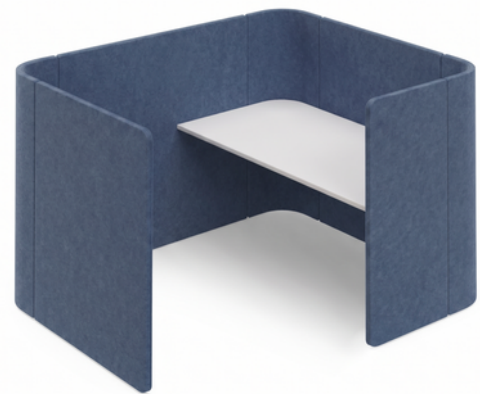

Designed for focused individual work, the Cove WorkPod provides a semi-private environment that minimizes distractions while maintaining an open and modern workspace feel. Its compact layout enhances space efficiency, making it ideal for agile workplaces and hot-desking environments.

XPS-Hexa Workpod



The Hexa WorkPod features an enclosed geometric design that enhances acoustic comfort and user concentration. Its high privacy panel structure creates dedicated personal work zones suited for focused tasks within open-plan offices.



XPS-Recap Workpod

The Recep WorkPod integrates reception functionality with a contemporary design, creating a welcoming workspace. Its curved shape promotes spatial flow and a professional appearance. Featuring soft edges, sleek lines, and high-quality finishes, it balances durability with aesthetics. Designed for both users and visitors, it offers ample desk space and integrated storage to keep the area organized. Ergonomically designed for comfort during extended use, the WorkPod is suitable for corporate lobbies or co-working spaces, exemplifying innovative design and functionality.

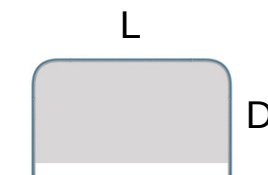

L : 1270 / 1570 / 1870
D : 735 / 885 / 935
H : 1050 / 1200 / 1350

XPS-Collab Workpod



Built for teamwork and interaction, the Collab WorkPod encourages collaboration through its open shared layout and integrated screen panel system. It creates a flexible environment for meetings, discussions, and collaborative planning.

.Adjustable Table.

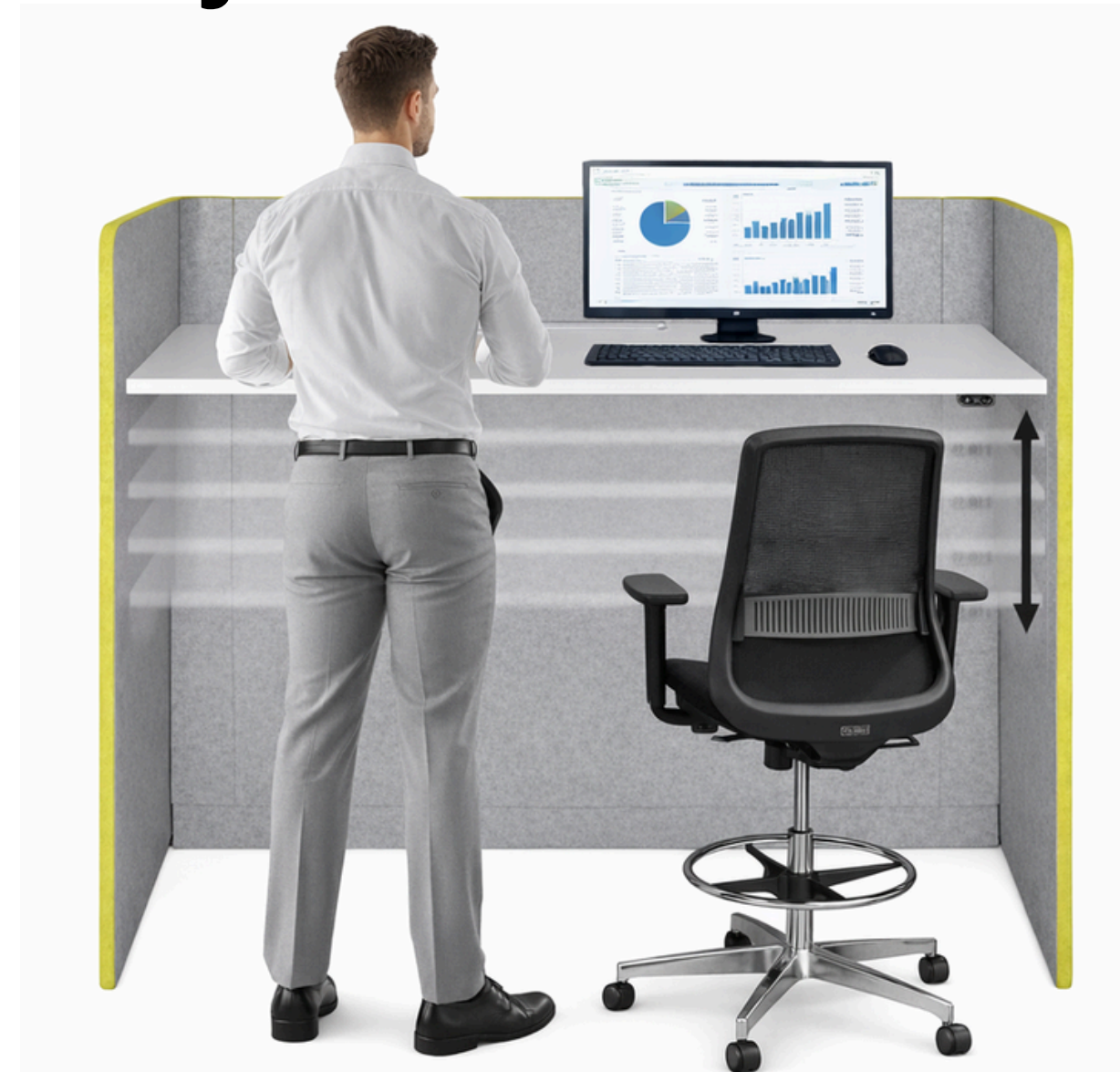

Redefine your comfort and productivity with a height-adjustable workstation that transitions easily between sitting and standing, boosting energy and focus. Its minimalist design and premium materials, clean, along with acoustic panels, create a quiet workspace while optimizing workflow.

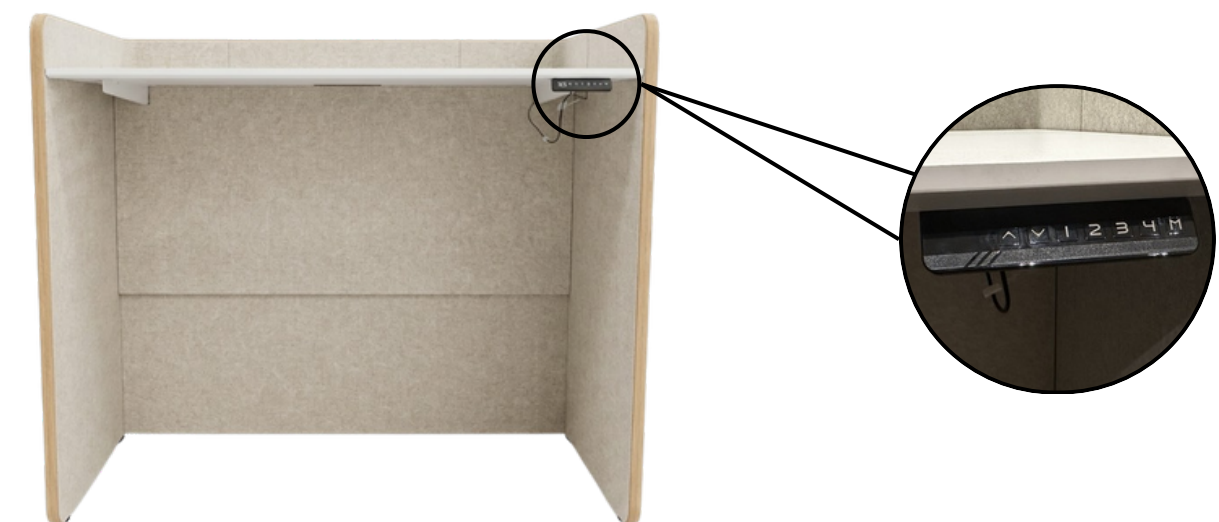

XPS-Conference Workpod



The Conference WorkPod offers a high-privacy workspace solution designed for concentrated work, virtual meetings, and quiet discussions. Its tall acoustic panels help reduce surrounding noise and create a focused working environment.

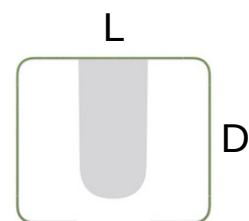

L : 2070
D : 1070 / 1570 / 2070
H : 1200 / 1350 / 1500

XPS-Uni Workpod



The Solo WorkPod delivers a personal retreat within busy workplaces, combining comfort, privacy, and functionality in one compact solution. Its lounge-inspired design supports focused work, casual meetings, and short breaks throughout the day.

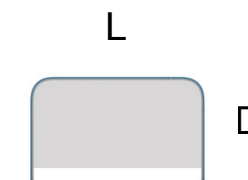

L : 1070 / 1570 / 2070
D : 650
H : 1200 / 1350 / 1500

Model XPP

Lounge Sofa / Side Table / Center Table



PS-100S
L 1000 X D 650 X H 760



PS-150S
L 1500 X D 650 X H 760



PS-200S
L 2000 X D 650 X H 760



PSA-100S
L 1000 X D 650 X H 760



PSA-80LS
L 800 X D 650 X H 760



PSA-80RS
L 800 X D 650 X H 760



PSA-150S
L 1500 X D 650 X H 760



PSA-200S
L 2000 X D 650 X H 760



TL-180R705
Standard Steel Base Cover
With Hairline Finish

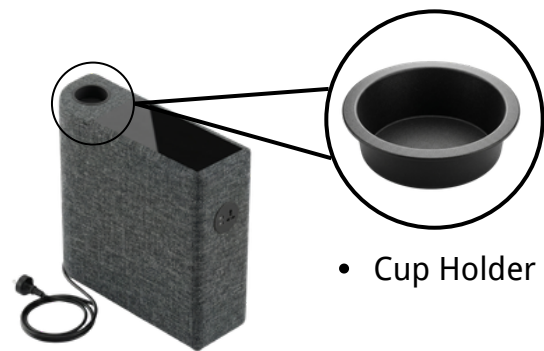

• Cup Holder

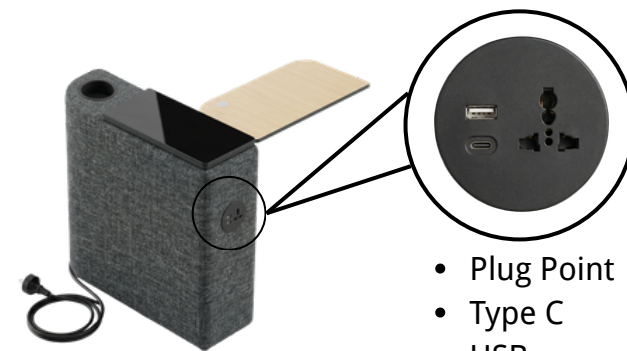

• Plug Point
• Type C
• USB



• Extend Metal Slider
• Wire Management
• Cup Holder

- Glass Top
- Wire Management
- Cup Holder

- Glass Top
- Extend Wooden Slider
- Wire Management
- Cup Holder

Model XPP - Pod With Sofa

Creating focus and collaboration zone.



U POD
1070 W X 685 D X 1200 H



U POD WITH ARMLESS SOFA
1070 W X 685 D X 1200 H



U POD WITH ARM SOFA
1070 W X 685 D X 1200 H



U POD WITH SIDE TABLE
AND SOFA
1070 W X 685 D X 1200 H



U POD WITH SOFA AND
SIDE TABLE (EXTEND
WOODEN SLIDER)
1070 W X 685 D X 1200 H



ENCLOSED POD
2070 W X 1570 D X 1350 H



ENCLOSED POD WITH TABLE
2070 W X 1570 D X 1350 H



ENCLOSED POD WITH TABLE
AND SOFA
2070 W X 1570 D X 1350 H

Model XDS

Divide Systems-30mm (R50)



GEO Divider panel Workstation

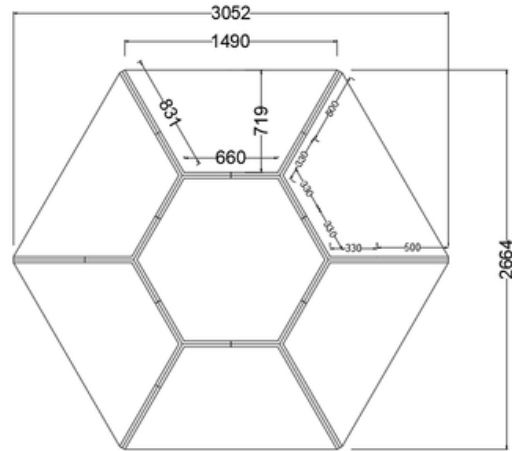

Array Divider panel Workstation

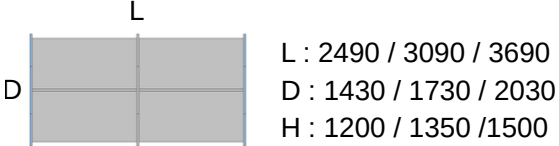
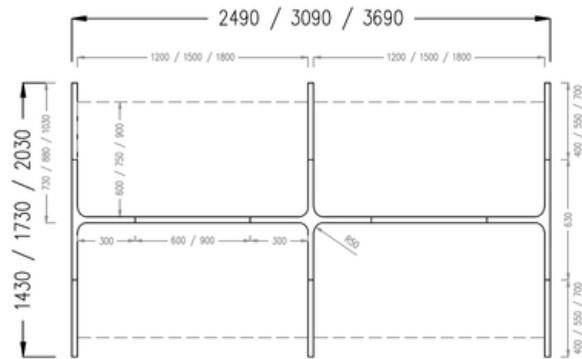

Y TRIP Divider panel Workstation

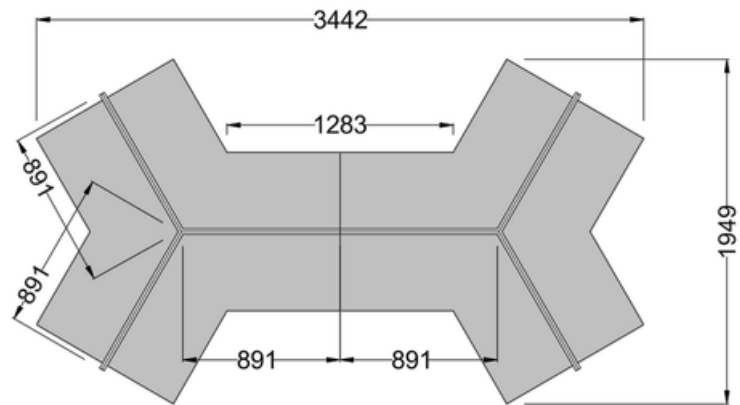

XPS-Array Divider panel Workstation

The XPS – Array Divider Panel Workstation creates organized team workspaces with enhanced visual privacy and a clean modern aesthetic. Its soft-edge divider panels provide acoustic comfort while maintaining an open collaborative environment.

XPS-Y TRIP Divider Panel Workstation

The XPS – Cluster Divider Panel Workstation is designed for modern collaborative environments, balancing connectivity and functionality. Its integrated divider panels create structured individual stations while promoting a cohesive team setting. Crafted from high-quality materials, the workstation boasts durability and a sleek aesthetic. Smart cable management keeps wires organized, and acoustically optimized panels reduce noise distractions. Its modular design allows easy reconfiguration, making it adaptable to changing workspace needs. Emphasizing ergonomic comfort and efficient space use, this workstation enhances productivity and collaboration in fast-paced business environments.



XPS-GEO Divider Panel Workstation

Workstation is designed to create structured and distraction-reduced work environments within open spaces. Its panel system provides visual separation and improved focus while maintaining a clean and modern workspace aesthetic.

Ideal for offices, study zones, and library environments, the divider panels help define personal work areas for enhanced concentration and quiet productivity. The modular layout allows flexible configurations to suit collaborative spaces, learning areas, and evolving workspace needs.



.features.

Highlight features across all our panel options



50mm Radius

Panels feature corner post radius of 50mm.

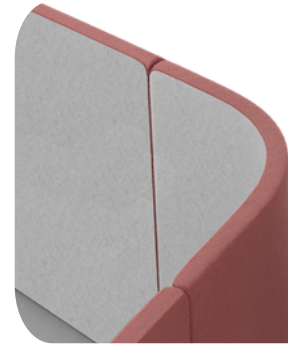

140mm Radius

Panels feature corner post radius of 140mm.



Adjustable Panel Feet

Micro-adjustable feet ensure precise leveling and stability.



Between Panel Center R15mm

Between Panels feature inner post radius of 15mm.



Detailed Stitching

Workmanship of meticulous stitching.



Top & Bottom 50mm Radius

The panels features rounded 50mm corners, adding a refined touch.

.optional.

Customize these features to your preference.



Magnetic Whiteboard

Easily move your magnetic whiteboard to any side



Hanging Shelf

Adorn your area with the included hook basket.



Hanging Rack

Elevate your area with the included hook basket for stylish decoration.



Hanging Hook

Decorate your space with included hook basket.

.wire management.

Customize your wire management of choice. Tidying up your wires, uncluttering your space.



Wire Snake

Route cable from the ground with flexible wire management snake.



Floor Trunking

Route cable from the ground with floor trunking.



Pole Trunking

Route cable from the ceiling with pole trunking.

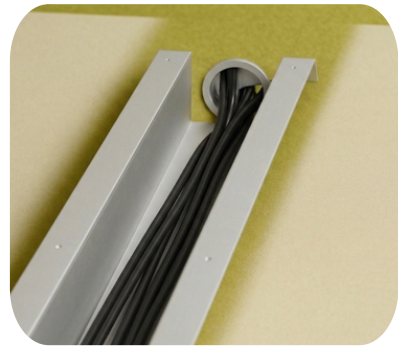

Wire Trunking

Under-table trunking to send wires to adjacent side.

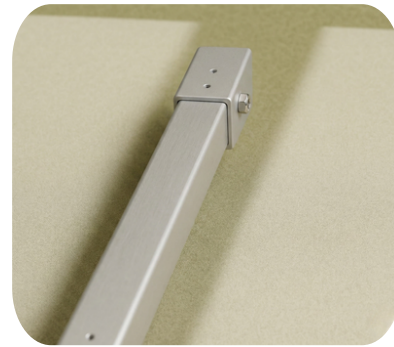

Support Trunking

Excellent table support, stable and sturdy.

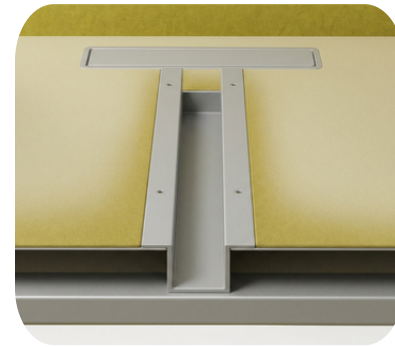

Bracket Trunking

Under-table trunking to send wires to opposite side.



L Bracket

Ensure coverage of the desktop.



Socketed

Grommet with fixed preinstalled socket (up to 4).

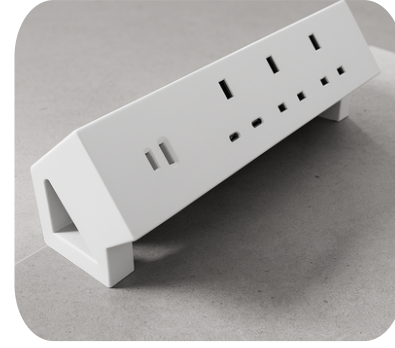

On-table socket

Easy access on-table socket, 1x USB-A, 1x USB-C.

.virtually hidden wires.

Workstation tables with advanced cable management systems provide flexible routing options, keeping cables concealed and contributing to a tidy, organized workspace that enhances overall design.



.virtually hidden wires.

Workstation tables with advanced cable management systems provide flexible routing options, keeping cables concealed and contributing to a tidy, organized workspace that enhances overall design.

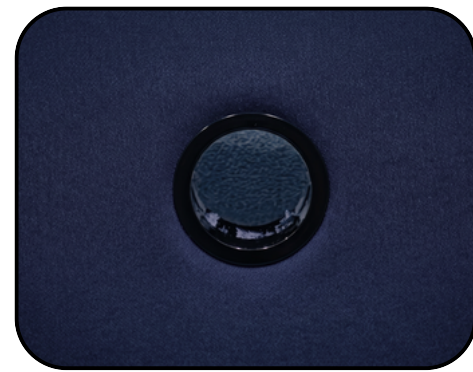

Hole
Diameter : 45mm

